



3 Channel Standard Series Aluminium Skirting Duct

Flush Mounted



CATALOGUE NO: 2002.F

- ❖ Wiring Installation Costs Slashed
- ❖ Easy to Install
- ❖ No maintenance – all aluminium body

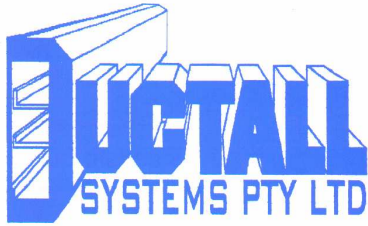

3 CHANNEL STANDARD SERIES ALUMINIUM SKIRTING DUCT

Catalogue No: 2002.F

Flush Mounted

MAIN FEATURES

- Easy to install (no measuring from floor)
- No maintenance (all metal)
- Accepts standard power, data and telephone skirting type accessories
- Cover plates simply drop in place
- 20mm carpet lip to allow duct to be mounted directly on slab
- All aluminium body (will not rust)

ACCESSORIES

1. Single power outlet mounting kit – 2002.F/SP.
2. Double power outlet mounting kit – 2002.F/DP.
3. Telephone outlet mounting kit – 2002.F/T.
4. Data outlet mounting kit – 2002.F/D.
5. End cover plate with fixing screws – 2002.F/E.
6. Right angle external corner – 2002.F/C.

NOTES

- Recommended fixing centres 800mm max.
- Over 130 special colours available on request (acrylic or powercoated)
- Standard duct in black three (3) metre length P.O.A.
- Medium voltage cables in duct to be double insulated type to save earth bonding covers and body.

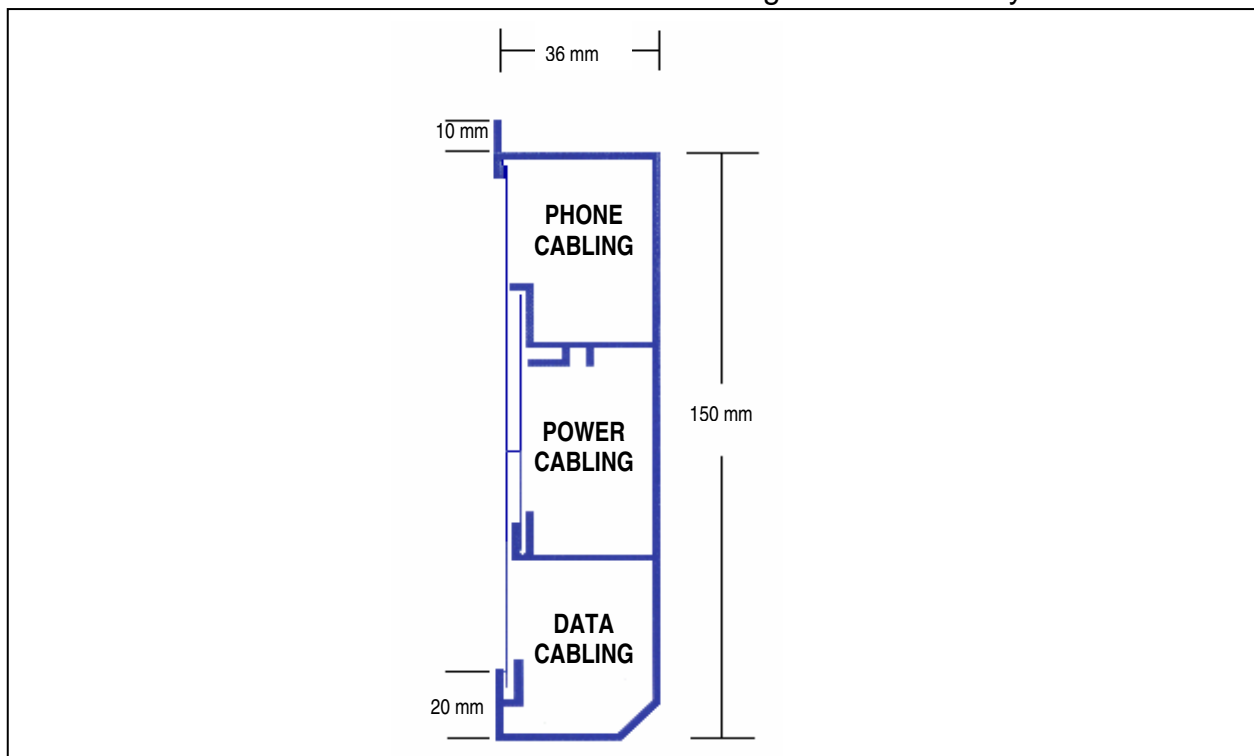

2002.F Skirting Duct

GENERAL:

The contractor shall supply and install the skirting duct system where shown on the drawings. The ducting system shall be complete with all factory made accessories.

COMPLIANCE:

The Contractor shall ensure that the entire skirting wiring duct installation complies with the requirements of the local supply Authority and Austel. All ducting shall be earthed.

TYPE:

The skirting wiring duct shall:-

- * Be extruded aluminium section.
- * Be a minimal size of 150mm x 36mm.
- * Have three (3) segregated wiring compartments for phone, power and miscellaneous cabling. The power channel shall be the middle compartment in the duct.
- * Have recesses for fishplates or dowel to align duct sections at joints.
- * Have front cover plates of sheet steel either powdercoated a nominated colour or affixed with a bonded vinyl film of selected colour similar to Marviplate and length of 2000mm. The cover plates shall be fitted without the use of fixing screws.
- * Have exposed duct body finished in baked enamel (powdercoated) of selected colour.
- * The duct shall be equal to Ductall Systems 2002.F skirting.

INSTALLATION:

The skirting wiring duct shall be fixed to walls alternatively at the top and bottom of the duct at maximum centres of 1000mm. All joints (butt, corner and angled) shall be neatly made in a tradesman like fashion with no visible gaps.

Supply and install wiring access via conduits within stud walls, etc. and associated draw wires, to all duct sections throughout this installation. Access shall be separate for each duct channel to maintain electrical isolation.